

ZigBee® - Ready RF Transceiver Modules

Product Description

The RC2400 and RC2400HP RF Transceiver Modules are a series of compact surface-mounted modules specially designed for the ZigBee® PRO protocol stack. It can also be used for other for wireless star and mesh networks based on IEEE 802.15.4 compliant PHY and MAC.

The complete shielded module is only 12.7 x 25.4 x 3.3 mm and comes in both a low current variant (RC2400) and a High Power version with LNA and power amplifier for extended range (RC2400HP). The two variants are pin compatible.

Applications

- Smart Metering / AMR / AMI
 - Electricity, gas, water and heat meters
 - Energy Service Portal (ESP) / Load Control
- IP sensor networks (6LoWPAN)
- RF4CE remote controls
- Wireless sensor networks/Building Automation

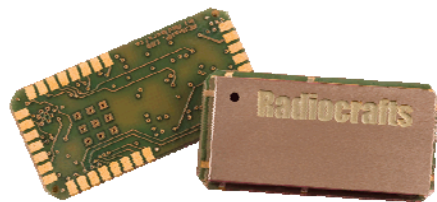

Features

- Complete ZigBee-ready module
- 100mW / 20 dBm option and low-power option in pin compatible packages
- 12.7 x 25.4 x 2.5 mm compact shielded module for SMD mounting
- IEEE 802.15.4 compliant PHY
- Single-cycle high performance 8051 microcontroller core
- 256 kB Flash memory, 8 kB SRAM
- 15 digital and analogue I/Os, 8 channel 12 bit ADC
- UART, SPI and debug interfaces
- On-board 32.768 kHz real time clock (RTC), 4 timers
- High performance direct sequence spread spectrum (DSSS) RF transceiver
- 2.0 – 3.6 V supply voltage, ultra low power modes
- Optional 4 kB internal EEPROM
- Conforms with EN 300 440 and EN 300 328 (Europe), FCC CFR 47 part 15 (US), ARIB STD-T66 (Japan) and G.S.R. 542(E)/45(E) (both for India)

Quick Reference Data (typical at 3.3V, frequency 2440 MHz)

Parameter	RC2400	RC2400HP	Unit
Frequency band	2.400-2.4835		GHz
Number of channels	16		
Data rate	250		kbit/s
Max output power	4	20*	dBm
Sensitivity (PER 1%)	-97	-99	dBm
Adjacent Channel Rejection	49		dB
Alternate Channel Rejection	57		dB
Supply voltage	2.0 - 3.6	2.7 - 3.6	Volt
Current consumption, RX/TX	24/34	27/175	mA
Current consumption, PD	0.4	1.3	uA
Flash memory	256		kB
RAM	8		kB

* Limited to 12 dBm in Europe due to ETSI regulation and limited to 10 dBm in US for frequency 2480MHz due to FCC regulation.

Internal EEPROM (optional)	4	kB
Operating Temperature	-30 to +85 (-40 to +85 available on request)	°C

Quick Product Introduction

The RC2400 series of modules are specially designed to comply with IEEE 802.15.4-based industry standards like ZigBee PRO, 6LoWPAN, Wireless HART, RC4CE and others. Using the module together with the TI Z-stack is a powerful combination to build any ZigBee profile and application. The module contains qualified RF hardware and enough processor power to run the complete ZigBee mesh network protocol for a full function device including the application.

Using a pre-qualified module is the fastest way to make a ZigBee product and shortest time to market. The embedded RF HW and MCU resources in a 100% RF tested and pre-qualified module shorten the qualification and approval process. No RF design or RF expertise is required to add powerful wireless networking to the product. In most cases you only need supply voltage (for example an external battery) and a sensor/actuator and the module can run the entire application.

The module can be used as

- RC2400/RC2400HP: HW platform. No preloaded firmware.
- RC2400-ZNM/RC2400HP-ZNM : A complete ZigBee PRO network module where the entire ZigBee Pro compliant stack and configurable application software is preloaded in module and available via API on a serial interface.

About this document

This document is one part of the documentation for the module. It describes the electrical parameters, RF performance, footprint and PCB layout and regulatory information. Depending on the selected FW solution one additional User Manual should be used. See

- RC2400/RC2400HP Firmware Development User Manual for using the module as a hardware platform only
- RC2400/RC2400HP-ZNM User Manual for details on how to use the ZNM module with preloaded ZigBee Pro stack and API through a serial interface.

RC2400/RC2400HP
Firmware Development User Manual

RC2400/RC2400HP-ZNM
User Manual

*Future
User Manuals*

RC2400/RC2400HP Datasheet (This document)

Figure 1 Document structure

Pin Assignment

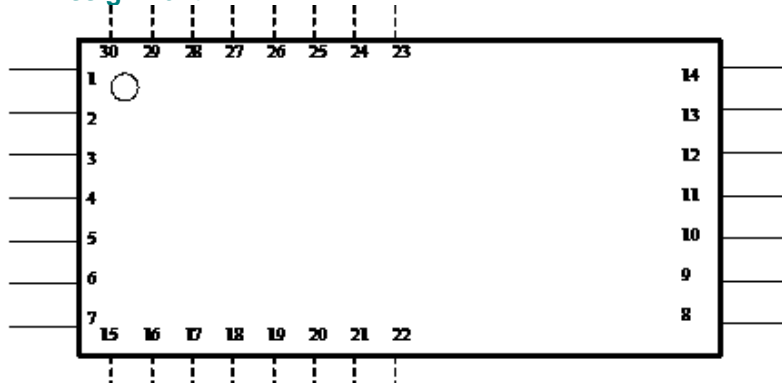

Pin Description

Pin no	Pin name	Description
1	GND	System ground
2	Digital I/O	Digital I/O
3	Digital I/O	Digital I/O
4	Digital I/O	Digital I/O
5	Digital I/O	Digital I/O
6	Digital I/O	Digital I/O
7	GND	System ground
8	GND	System ground
9	RF	RF I/O connection to antenna
10	GND	System ground
11	NC	Not Connected
12	Reset	Reset. Active Low
13	VCC	Supply voltage input. Internally regulated.
14	GND	System ground
15	Digital I/O/ LNA Gain mode	Digital I/O/ LNA Gain control for RC2400HP
16	Digital I/O	Digital I/O
17	Digital I/O	Digital I/O
18	Digital I/O	Digital I/O
19	Digital I/O /DD	Digital I/O. Debug interface is used for programming.
20	Digital I/O	Digital I/O. Debug interface is used for programming.
21	Digital I/O	Digital I/O
22	Digital I/O LNA_Enable	Digital I/O / LNA Enable for RC2400HP
23	Digital I/O /32kHz_Q1	Internal 32 kHz oscillator. Do not connect. (Digital I/O if no xtal)
24	Digital I/O /32kHz_Q2	Internal 32 kHz oscillator. Do not connect. (Digital I/O if no xtal)
25	Digital I/O	Digital I/O
26	Digital I/O	Digital I/O
27	Digital I/O	Digital I/O
28	Digital I/O	Digital I/O
29	Digital I/O PA_Enable	Digital I/O / PA Enable for RC2400HP
30	Digital I/O	Digital I/O

Note 1: For detailed pin description, see respective User Manual

Note 2: Pins 17 and 18 are suggested as I2C interface. They can be configured otherwise, but are connected to an optional internal EEPROM with I2C address = 000. It is recommended to leave these pins as I2C. Sensors and actuators or any other I2C device can be connected to these pins and accessed from the module.

Block Diagram

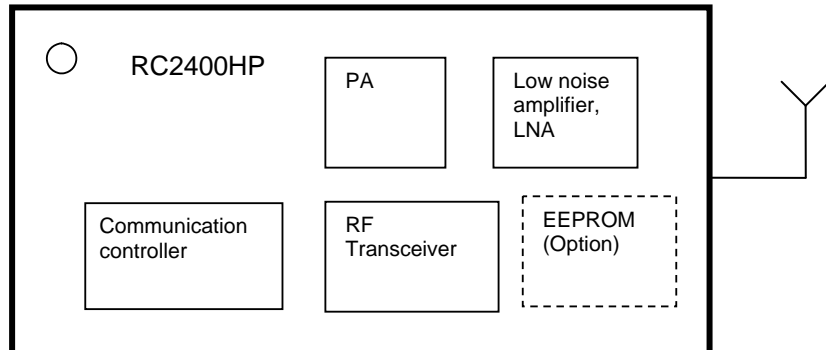

Programming and debugging Interface

For downloading firmware to the module it is required to include a 2x5 pins programming connector to the modules programming pins. The connector should be a 2.54 mm pitch pin-row (same pitch in both directions), SMD or through-hole version, with the following connections:

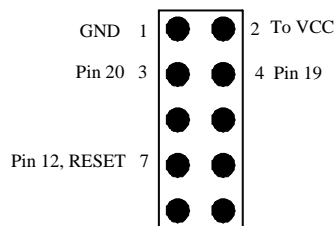

RF Frequency, Output Power Levels and Data Rates

The following table shows the RF channels as defined by the IEEE 802.15.4 standard.

RF channel	Frequency
11	2405 MHz
12	2410 MHz
13	2415 MHz
14	2420 MHz
15	2425 MHz
16	2430 MHz
17	2435 MHz
18	2440 MHz
19	2445 MHz
20	2450 MHz
21	2455 MHz
22	2460 MHz
23	2465 MHz
24	2470 MHz
25	2475 MHz
26	2480 MHz

For proprietary solutions (non-IEEE 802.15.4), the RF transceiver can be programmed in steps of 1 MHz.

The RF transceiver uses direct sequence spread spectrum (DSSS) with 2 Mchip/s chip rate, giving a raw data rate of 250 kbit/s. The modulation format is Offset – Quadrature Phase Shift Keying (O-QPSK). The DSSS makes the communication link robust in noisy environments, which is beneficial when sharing the same frequency band with other applications.

Output power

The output power can be programmed in a 25-27 dB range. Maximum power setting (TXPOWER=0xF5) gives 20 dBm output power for RC2400HP and 4 dBm output power for RC2400. Battery lifetime considerations and compliance to local maximum output power regulations will influence the output power setting.

Battery operation might require lower peak currents and hence reduced output power, especially for the RC2400HP. See table below.

Typical values for RC2400HP at 25°C, 3.3V, Freq = 2440 MHz, 50 ohm matched antenna impedance.

Power setting (TXPOWER)	Output power (dBm)	Peak current (mA)
0xF5	20,3	218
0xE5	19,5	192
0xD5	18,8	174
0xC5	18,1	160
0xB5	17,2	145
0xA5	16,2	134
0x95	14,5	121
0x85	13,5	112
0x75	12,0	99
0x65	10,5	93

Regulatory Compliance Information

The use of RF frequencies and maximum allowed transmitted RF power is limited by national regulations. The RC2400HP has been designed to comply with world wide regulations (R&TTE directive 1999/5/EC in Europe FCC, ARIB and G.S.R. 542(E)/45(E) for India). The RC2400 (non-HP) complies with all directives and regulations at any power lever setting. In order to comply with the different standards, the output power for RC2400HP should be configured as commented below.

R&TTE directive (EU)

According to R&TTE directive it is the responsibility of Radiocrafts' customers to check that the host product (i.e. final product) is compliant with R&TTE essential requirements. The use of a CE marked radio module can avoid re-certification of the final product, provided that the end user respects the recommendations established by Radiocrafts. A Declaration of Conformity is available from Radiocrafts on request.

In terms of R&TTE the RC2400HP is a wideband radio and must comply with EN 300 328 on those premises. This implies that the radiated power must be lower than 12 dBm and hence power setting giving 12 dBm or lower can be used in compliance to EN 300 328.

FCC/IC compliance (US, Canada)

These devices comply with Part 15 of the FCC Rules.

Part number	FCC ID	IC ID
RC2400	Y2NRC24XX	IC 9402A-RC24XX
RC2400HP	Y2NRC24XXHP	IC 9402A-RC24XXHP

Operation is subject to the following two conditions: (1) this device may not cause harmful interference, and (2) this device must accept any interference received, including interference that may cause undesired operation.

Son fonctionnement est soumis aux deux conditions: (1) cet appareil ne doit pas créer d'interférences nuisibles et (2) cet appareil doit accepter toute interférence reçue, y compris les interférences qui peuvent en perturber le fonctionnement.

Changes or modifications to the equipment not expressly approved by the party responsible for compliance could void the user's authority to operate the equipment.

If an detachable RF connector is introduced in RF path it must be a non-standard type RP-SMA, U.FI etc. The modules have been approved with the following external quarter wave antennas:

Manufacturer	Part number
EAD	Acara
Taoglas	FXP73.07.0100A
Antennova	Titanis
	PCB inverted F antenna*

* Contact support@radiocrafts.com for specification of antenna in order to comply with FCC certification.

Any use of other antenna with gain > 2.5 dBi is strictly forbidden.

Warning for RC2400HP: This is device complies with FCC RF radiation exposure limits set forth for an uncontrolled environment. The antenna used for this transmitter must be installed to provide a separation distance of at least 20 cm from all persons and must not be co-located or operating in conjunction with any other antenna or transmitter. For approval of end product as portable device, separate SAR tests and approval is required for end product.

Avertissement concernant le module RC2400HP: Le module RC2400 HP est conforme à l'exposition aux limites de rayonnements RF FCC acceptées pour un environnement non contrôlé. L'antenne utilisée pour cet émetteur doit être installée pour fournir une distance minimum 20 cm par rapport à toute personne et ne doit pas être à côté ou fonctionner conjointement avec une autre antenne ou transmetteur. Pour l'approbation du produit final en tant que périphérique portable, des tests et homologations SAR propres au produit sont requis.

The output power of RC2400 is below the FCC threshold requiring that it be tested for SAR compliance.

La puissance de sortie du RC2400 est inférieure au seuil FCC nécessitant que des tests de conformité SAR soient réalisés

This device has been designed to operate with an quarter wave antenna having a maximum gain of 2.5 dBi. Antenna having a higher gain is strictly prohibited per regulations of Industry Canada. The required antenna impedance is 50 ohms.

Cet appareil a été conçu pour fonctionner avec une antenne 1/ d'ondes ayant un gain maximum de 2,5 dBi. Utiliser une antenne à gain plus élevé est strictement interdite par les règlements d'Industrie Canada. L'impédance d'antenne requise est de 50 ohms

To reduce potential radio interference to other users, the antenna type and its gain should be so chosen that the equivalent isotropically radiated power (EIRP) is not more than that required for successful communication.

Pour réduire le risque d'interférence pour les autres utilisateurs, le type d'antenne et son gain doivent être choisies de façon que la puissance isotrope rayonnée équivalente (PIRE) n'est pas supérieure à celle requise pour une communication réussie.

The installer of this radio equipment must ensure that the antenna is located or pointed such that it does not emit RF field in excess of Health Canada limits for the general population; consult Safety Code 6, obtainable from Health Canada's website www.hc-sc.gc.ca/rpb

Le programme d'installation de cet équipement radio doit s'assurer que l'antenne est située ou orientée de façon à ne pas émettre de champ RF dépassant les limites de Santé Canada pour la population en général, consulter le Code de sécurité 6, disponible sur le site Web de Santé Canada www.hc-sc.gc.ca/rpb

End product marking FCC/IC

The end product including the module must include the following text on a visible label: The French part is only required for product with IC compliance.

For RC240x

Contains Transmitter Module FCC ID: Y2NRC24XX/IC: 9402A-RC24XX
Operation is subject to the following two conditions: (1) this device may not cause harmful interference, and (2) this device must accept any interference received, including interference that may cause undesired operation.

Module transmetteur ID IC: 9402A-RC24XX
Son fonctionnement est soumis aux deux conditions suivantes: (1) cet appareil ne doit pas causer d'interférences nuisibles et (2) cet appareil doit accepter toute interférence reçue, y compris les interférences qui peuvent perturber le fonctionnement.

For RC240xHP

Contains Transmitter Module FCC ID: Y2NRC24XXHP/IC: 9402A-RC24XXHP
Operation is subject to the following two conditions: (1) this device may not cause harmful interference, and (2) this device must accept any interference received, including interference that may cause undesired operation.

Module transmetteur ID IC: 9402A-RC24XX
Son fonctionnement est soumis aux deux conditions suivantes: (1) cet appareil ne doit pas causer d'interférences nuisibles et (2) cet appareil doit accepter toute interférence reçue, y compris les interférences qui peuvent perturber le fonctionnement.

WPC compliance (India)

License based operation in India is based on case by case grant and the basis is often a compliance to the R&TTE directive or to FCC.

ARIB compliance

The RC2400HP has been designed to comply with the requirements given by the Japanese ARIB STD-T66 for low power (short range) devices in the 2.4GHz range. However, it has not been formally assessed for conformity with the appropriate regulations. Users must assess and verify that their final product meets the appropriate specifications and to perform the required procedures for regulatory compliance.

The relevant regulations are subject to change. Radiocrafts AS do not take responsibility for the validity and accuracy of the understanding of the regulations referred above. Radiocrafts only guarantee that this product meets the specifications in this document. Radiocrafts is exempt from any responsibilities related to regulatory compliance.

Antenna and Range Considerations

The module needs an antenna to operate. The following antenna options could be considered.

Antenna	Advantage	Disadvantage	Estimated LOS range (meters) RC2400	Estimated LOS range (meters) RC2400HP (100 mW)
PCB, quarter wave monopole	Low cost, easy to implement		250-400	2000-2500
PCB Pifa	Low cost	Sensitive to surroundings	300-500	2500-3000
Chip antenna (7x2mm example)	Small size	Medium performance	200-300	1500-2000
External whip monopole	High performance	Physically large, higher cost	500-700	3000-4000
External whip dipole	High performance, no large ground plane required	Physically large, higher cost	500-700	3000-4000

Using an antenna, the VSWR (Voltage Standing Wave Ratio) of the antenna should be less than 2:1. The VSWR is normally specified in the antenna datasheet and most commercial available antennas fulfil this requirement. If you design a PCB antenna this is an important input requirement for such a design. Using a VSWR higher than 2:1, will result in unwanted reflected power into the module and reducing both the module performance and radiated power. This will in turn reduce the range. Using a VSWR higher than 3:1 is not recommended.

The antenna shall be connected to the RF pin. The RF pin is matched to 50 Ohm. In the case that an antenna connector for an external antenna is placed away from the module at the motherboard, the trace between the RF pin and the connector should be a 50 Ohm transmission line. Follow these general guidelines;

On a two layer board made of FR4 the width of the routing trace, from the RF-pin to any connector or contact point for a PCB-antenna, should be 1.8 times the thickness of the board, assuming a dielectric constant of 4.8 (normal value for a FR-4 board). The line should be run at the top of the board and on the bottom side there should be a ground plane. This will give a transmission line with close to 50 ohm characteristic impedance.

Example: For a 1.6 mm thick FR4 board, the width of the trace on the top side should be $1.8 \times 1.6 \text{ mm} = 2.88 \text{ mm}$.

The easiest antenna to use is the quarter wave whip antenna. A quarter wave whip antenna above a ground plane yields 37 Ohm impedance and a matching circuit for 50 Ohm is not required. A quarter wave antenna implemented with a piece of wire normal to the ground plane should have a length equivalent to 95% of the free space wavelength.

A PCB antenna can be made as a copper track where the ground plane is removed on the back side. The rest of the PCB board should have a ground plane as large as possible, preferably as large (in one dimension) as the antenna itself, to make it act as an electrical counterweight to the antenna. A quarter wavelength antenna on a PCB must be shorter than the wire antenna due to the influence of the dielectric material of the PCB. The length reduction depends on the PCB thickness and material, as well as how close to the edge of the board the antenna is placed. Typical reduction is to 75-90 % of the length in free space

but exact length must be found empirically. A 1.0 or 1.6 mm FR4 PCB with the antenna trace > 1 cm from conducting obstacles normally reduces the length of a quarter wave antenna to about 2.4 cm.

If, for space reasons, the track is made even shorter than the resonating quarter of a wavelength, the antenna should be matched to 50 ohms using a series inductor and a shunt capacitor.

The length of a quarter-wave antenna is given in the table below.

Frequency [MHz]	Length of whip antenna [cm]	Length of PCB track [cm]
2450	2.9	2.25 – 2.7

PCB Layout Recommendations

The recommended layout pads for the module are shown in the figure below. All dimensions are in thousands of an inch (mil). The circle in upper left corner is an orientation mark only, and should not be a part of the copper pattern.

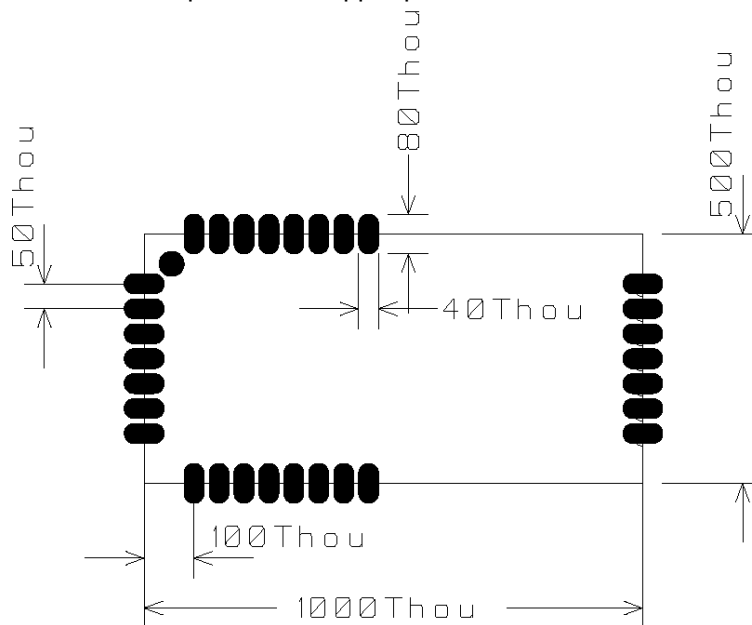

A PCB with two or more layers and with a solid ground plane in one of the inner- or bottom layer(s) is recommended. All GND-pins of the module shall be connected to this ground plane with vias with shortest possible routing, one via per GND-pin.

On the back side of the module there are several test pads. These test pads shall not be connected, and the area underneath the module should be covered with solder resist. If any routing or vias is required under the module, the routing and vias must be covered with solder resist to prevent short circuiting of the test pads. It is recommended that vias are tented.

Reserved pins should be soldered to the pads, but the pads must be left floating.

Note that Radiocrafts technical support team is available for free-of-charge schematic- and layout review of your design.

Mechanical Drawing

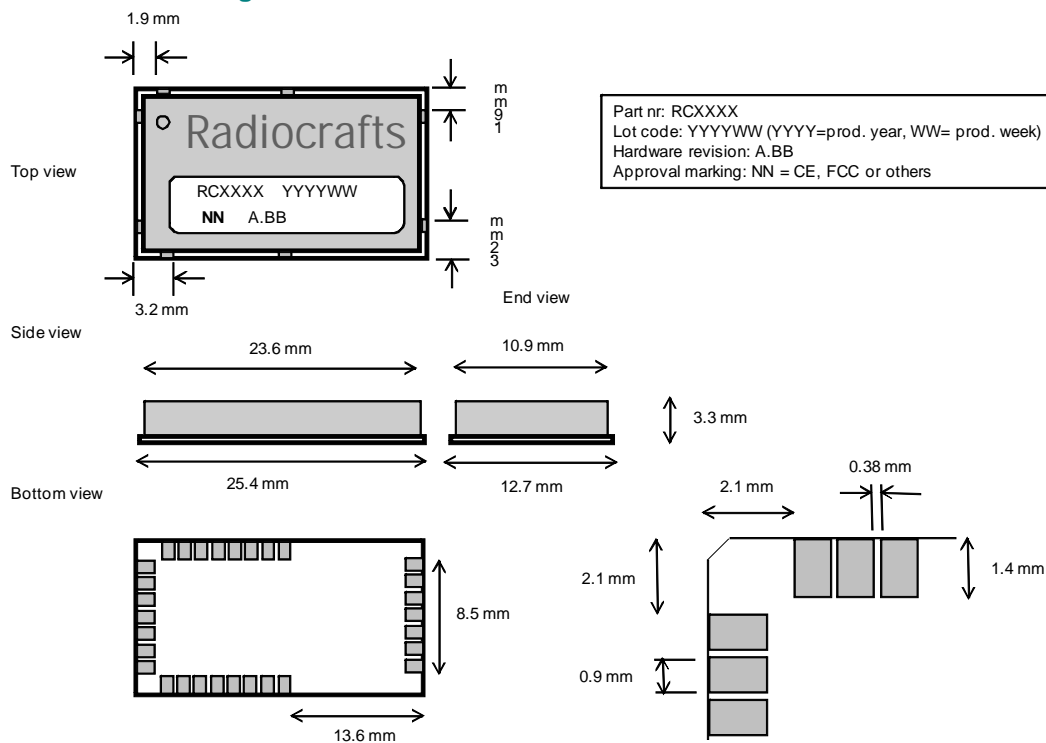

Drawings are not to scale

Mechanical Dimensions

The module size is 12.7 x 25.4 x 3.3 mm.

Carrier Tape and Reel Specification

Carrier tape and reel is in accordance with EIA Specification 481.

Tape width	Component pitch	Hole pitch	Reel diameter	Units per reel
44 mm	16 mm	4 mm	13"	Max 1000

Soldering Profile Recommendation

JEDEC standard IPC/JEDEC J-STD-020D.1 (page 7 and 8), Pb-Free Assembly is recommended.

The standard requires that the heat dissipated in the "surroundings" on the PCB is taken into account. The peak temperature should be adjusted so that it is within the window specified in the standard for the actual motherboard.

Aperture for paste stencil is normally areal-reduced by 20-35%, please consult your production facility for best experience aperture reduction. Nominal stencil thickness of 0.1-0.12 mm recommended.

Absolute Maximum Ratings

Parameter	Min	Max	Unit
Supply voltage, VCC	-0.3	3.6	V
Voltage on any pin	-0.3	VCC+0.5	V
Input RF level		10	dBm
Storage temperature	-40	85	°C
Operating temperature	-30	85	°C

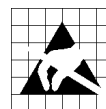

Caution ! ESD sensitive device.
Precaution should be used when handling the device in order to prevent permanent damage.

Under no circumstances the absolute maximum ratings given above should be violated. Stress exceeding one or more of the limiting values may cause permanent damage to the device.

Electrical Specifications

T=25°C, VCC = 3.3V, 50 ohm if nothing else stated.

Parameter	Min	Typ.	Max	Unit	Condition / Note
Operating frequency	2400		2483	MHz	Programmable in 1 MHz steps, 5 MHz steps for IEEE 802.15.4 compliance
Number of channels		16			For IEEE 802.15.4 compliance
Channel spacing		5		MHz	For IEEE 802.15.4 compliance
Input/output impedance		50		Ohm	
Data rate		250		kbit/s	
DSSS chip rate		2		Mc/s	
Frequency stability			+/-40	ppm	
Transmit power RC2400 RC2400HP	-23 -6		4 20	dBm	Programmable from firmware
Harmonics RC2400 2 nd harmonic 3 rd harmonic RC2400HP (19 dBm Pout) 2 nd harmonic 3 rd harmonic		-42 -55 -44 -42			Compliance to FCC requires less than - 27 dBm given TX duty cycle of 20% and 0dBi antenna gain at harmonic frequencies.
Spurious emission RC2400HP, TX, 20 dBm 30 – 1000 MHz 1-12.75 GHz RC2400 TX, 4 dBm 30 – 1000 MHz 1-12.75 GHz 1.8-1.9 GHz 5.15-5.3 GHz			-50 -45 -56 -48 -53 -60	dBm	Complies with EN 300 328, EN 300 440, FCC CRF47 Part 15 and ARIB STD-T66
Sensitivity RC2400 RC2400HP		-97 -99		dBm	PER = 1%
Adjacent channel rejection +/- 5 MHz		49		dB	At -82 dBm, PER = 1%. 0 dB for IEEE 802.15.4 compliance
Alternate channel selectivity +/- 10 MHz		57		dB	At -82 dBm, PER = 1%. 30 dB for IEEE 802.15.4 compliance

Parameter	Min	Typ.	Max	Unit	Condition / Note
Saturation		10		dBm	
Spurious emission, RX 30 -1000 MHz 1-12.75 GHz			-57 -47	dBm	Complies with EN 300 328, EN 300 440, FCC CRF47 Part 15 and ARIB STD-T66
Supply voltage RC2400 RC2400HP	2.0 2.7		3.6 3.6	V	
Current consumption, RX RC2400 RC2400HP		24 27		mA	MCU in Idle mode using the 32 MHz oscillator.
Current consumption, TX RC2400, 4dBm RC2400HP, 19 dBm		34 175		mA	MCU in Idle mode using the 32 MHz oscillator.
Current consumption, Power down RC2400 RC2400HP		0.4 1.3		μA	Wake-up time to power mode 0 is 54 uS
RAM memory		8		kB	
MCU clock frequency		32		MHz	
MCU low frequency crystal		32.768		kHz	
Antenna VSWR		<2:1	3:1		

Ordering Information

Ordering Part Number	Description
RC2400	ZigBee-ready RF module, 256 kB Flash
RC2400HP	ZigBee-ready RF module, 256 kB Flash. High power, long range
RC2400 -EE	ZigBee-ready RF module, 256 kB Flash, including EEPROM
RC2400HP -EE	ZigBee-ready RF module, 256 kB Flash. High power, long range, including EEPROM
RC2400-ZNM	ZigBee-ready RF module, embedded ZigBee stack with API through serial interface
RC2400HP-ZNM	ZigBee-ready RF module, embedded ZigBee stack with API through serial interface. High power, long range
RC2400-ZNM-SE	ZigBee-ready RF module, embedded ZigBee stack with API through serial interface. Includes support for Smart Energy Security.
RC2400HP-ZNM-SE	ZigBee-ready RF module, embedded ZigBee stack with API through serial interface. High power, long range. Includes support for Smart Energy Security.

Document Revision History

Document Revision	Changes
1.0	First release
1.1	Corrected soldering profile info Added info in RC2405 and ZNM-SE variants Updated FCC information Updated Adjacent channel rejection
1.2	Updated FCC/IC information Status changed to Full Production

Product Status and Definitions

Current Status	Data Sheet Identification	Product Status	Definition
	Advance Information	Planned or under development	This data sheet contains the design specifications for product development. Specifications may change in any manner without notice.
	Preliminary	Engineering Samples and First Production	This data sheet contains preliminary data, and supplementary data will be published at a later date. Radiocrafts reserves the right to make changes at any time without notice in order to improve design and supply the best possible product.
X	No Identification Noted	Full Production	This data sheet contains final specifications. Radiocrafts reserves the right to make changes at any time without notice in order to improve design and supply the best possible product.
	Not recommended for new designs	Last time buy available	Product close to end of lifetime
	Obsolete	Not in Production Optionally accepting order with Minimum Order Quantity	This data sheet contains specifications on a product that has been discontinued by Radiocrafts. The data sheet is printed for reference information only.

Disclaimer

Radiocrafts AS believes the information contained herein is correct and accurate at the time of this printing. However, Radiocrafts AS reserves the right to make changes to this product without notice. Radiocrafts AS does not assume any responsibility for the use of the described product; neither does it convey any license under its patent rights, or the rights of others. The latest updates are available at the Radiocrafts website or by contacting Radiocrafts directly.

As far as possible, major changes of product specifications and functionality, will be stated in product specific Errata Notes published at the Radiocrafts website. Customers are encouraged to check regularly for the most recent updates on products and support tools.

Trademarks

RC232™ is a trademark of Radiocrafts AS. The RC232™ Embedded RF Protocol is used in a range of products from Radiocrafts. The protocol handles host communication, data buffering, error check, addressing and broadcasting. It supports point-to-point, point-to-multipoint and peer-to-peer network topologies.

All other trademarks, registered trademarks and product names are the sole property of their respective owners.

Life Support Policy

This Radiocrafts product is not designed for use in life support appliances, devices, or other systems where malfunction can reasonably be expected to result in significant personal injury to the user, or as a critical component in any life support device or system whose failure to perform can be reasonably expected to cause the failure of the life support device or system, or to affect its safety or effectiveness. Radiocrafts AS customers using or selling these products for use in such applications do so at their own risk and agree to fully indemnify Radiocrafts AS for any damages resulting from any improper use or sale.

© 2011, Radiocrafts AS. All rights reserved.

Contact Information

Web site: www.radiocrafts.com

Email: radiocrafts@radiocrafts.com

Address:

Radiocrafts AS
Sandakerveien 64
NO-0484 OSLO
NORWAY

Tel: +47 4000 5195

Fax: +47 22 71 29 15

E-mail: sales@radiocrafts.com
support@radiocrafts.com